

# Diaphragm pressure gauge with electrical output signal

## For the process industry, high overload safety to 40, 100 or 400 bar

### Models PGT43HP.100 and PGT43HP.160

WIKA data sheet PV 14.07



for further approvals see  
page 5

**intelliGAUGE®**

### Applications

- Acquisition and display of processes
- Output signals 4 ... 20 mA, 0 ... 20 mA, 0 ... 10 V for the transmission of process values to the control room
- For measuring points with increased overload of 40, 100 or 400 bar
- Easy-to-read, analogue on-site display needing no external power
- Safety-related applications

### Special features

- No configuration necessary due to “plug-and-play”
- Scale ranges from 0 ... 16 mbar
- Wide choice of special materials
- For gaseous, liquid and aggressive media, also in aggressive environments, due to all stainless steel construction
- Safety version S3 per EN 837

### Description

Wherever the process pressure has to be indicated locally and, at the same time, a signal transmission to the central control or remote centre is desired, the model PGT43HP intelliGAUGE® (patent, property right: e.g. DE 202007019025) can be used. Due to the metallic pressure element limit stop, these instruments have a high overload safety in the ranges of 40, 100 and 400 bar.

The intelliGAUGE® model PGT43HP fulfils all safety-related requirements of the relevant standards and regulations for the on-site display of the working pressure of pressure vessels. An additional measuring point for mechanical pressure display can thus be saved.

The model PGT43HP is based upon a model 432.36 high-quality, stainless steel safety pressure gauge with a nominal size of 100 or 160. The pressure measuring instrument is manufactured in accordance with EN 837-3.

**intelliGAUGE® model PGT43HP**

The robust diaphragm measuring system produces a pointer rotation proportional to the pressure. An electronic angle encoder, proven in safety-critical automotive applications, determines the position of the pointer shaft – it is a non-contact sensor and therefore completely free from wear and friction. From this, the electrical output signal proportional to the pressure, e.g. 4 ... 20 mA, is produced. The measuring span (electrical output signal) is adjusted automatically along with the mechanical display, i.e. the scale over the full display range corresponds to 4 ... 20 mA. The electrical zero point can also be set manually.

The electronic WIKA sensor, integrated into the high-quality pressure gauge, combines the advantages of electrical signal transmission with a local mechanical display that remains readable during a power failure.

An additional measuring point for mechanical pressure display can thus be saved.

## Specifications

| Model PGT43HP.100 and PGT43HP.160              |   |
|--|---|
| Nominal size in mm                             | <ul style="list-style-type: none"> <li>■ 100</li> <li>■ 160</li> </ul>  |
| Accuracy class                                 | 1.6<br>Option:<br>1.0 <sup>1)</sup>   |
| Scale ranges <sup>2)</sup>                     | 0 ... 16 mbar to 0 ... 250 mbar (flange Ø 160 mm)<br>0 ... 400 mbar to 0 ... 40 bar (flange Ø 100 mm)<br>other units (e.g. psi, kPa) available<br>or all other equivalent vacuum or combined pressure and vacuum ranges   |
| Scale  | Single scale<br>Option:<br>Dual scale   |
| Pressure limitation                            |   |
| Steady   | Full scale value  |
| Fluctuating                                    | 0.9 x full scale value  |
| Overload safety <sup>2)</sup>                  | <ul style="list-style-type: none"> <li>■ 40 bar</li> <li>■ 100 bar</li> <li>■ 400 bar (only for scale ranges <math>\geq 0 \dots 400</math> mbar<sup>3)</sup>)</li> </ul> Option:<br>Vacuum safety to -1 bar   |
| Process connection with lower measuring flange | <ul style="list-style-type: none"> <li>■ G ½ B</li> <li>■ ½ NPT</li> <li>■ ½ NPT female</li> <li>■ Open connecting flange DN 25 PN 40 per EN 1092-1, form B</li> <li>■ Open connecting flange DN 50 PN 40 per EN 1092-1, form B</li> <li>■ Open connecting flange 1" class 300, RF per ASME B16.5</li> <li>■ Open connecting flange 2" class 300, RF per ASME B16.5</li> </ul> and other threaded connections and open connecting flanges per EN/ASME from DN 15 to DN 80 (see data sheet IN 00.10) |
| Permissible temperature <sup>4)</sup>          |   |
| Medium   | +100 °C [+212 °F] maximum<br>Option:<br>+200 °C [+392 °F] maximum   |
| Ambient  | -20 ... +60 °C [-4 ... +140 °F]   |
| Temperature effect                             | When the temperature of the measuring system deviates from the reference temperature (+20 °C):<br>max. $\pm 0.8$ %/10 K of full scale value   |
| Case   | Safety version S3 per EN 837: With solid baffle wall (Solidfront) and blow-out back<br>Instruments with liquid filling with compensating valve to vent case   |
| Case filling                                   | Without<br>Option:<br>With silicone oil M50 case filling, ingress protection IP65   |

1) Application test required

2) Depending on scale range and overload safety, different flange Ø apply. See dimensions from page 6.

3) 400 bar overload safety for scale ranges < 400 mbar on request

4) For hazardous areas, the permissible temperatures of the output signal variant 2 will apply exclusively (see page 4). These must not be exceeded at the instrument either (for details see operating instructions). If necessary, measures for cooling (e.g. syphon, instrumentation valve, etc.) have to be taken.

## Model PGT43HP.100 and PGT43HP.160

| <b>Wetted materials</b>   |  |
|---|--|
| Diaphragm element (pressure element)  | ≤ 0.25 bar: Stainless steel 316L<br>> 0.25 bar: NiCr alloy (Inconel)<br>Option: Coated with special materials such as PTFE, Hastelloy, Monel, nickel, tantalum, titanium, silver (instruments with accuracy class 2.5) |
| Process connection with lower measuring flange  | Stainless steel 316L<br>Option: Lined/coated with special materials such as PTFE, Hastelloy, Monel, nickel, tantalum, titanium, silver   |
| Pressure chamber sealing  | FPM/FKM  |
| <b>Non-wetted materials</b>   |  |
| Case with upper measuring flange and flange connecting screws, movement, bayonet ring | Stainless steel  |
| Dial  | Aluminium, white, black lettering  |
| Instrument pointer  | Aluminium, black   |
| Set pointer   | Aluminium, red   |
| Window  | Laminated safety glass   |
| <b>Ingress protection per IEC/EN 60529</b>  | IP54<br>Option:<br>IP65  |

## Accessories

- Sealings (model 910.17, see data sheet AC 09.08)
- Valves (models IV20/IV21, see data sheet AC 09.19, and models IV10/IV11, see data sheet AC 09.22)
- Syphons (model 910.15, see data sheet AC 09.06)
- Cooling element (model 910.32, see data sheet AC 09.21)
- Switch contacts (see data sheet AC 08.01)

## Models PGT43HP.100 and PGT43HP.160

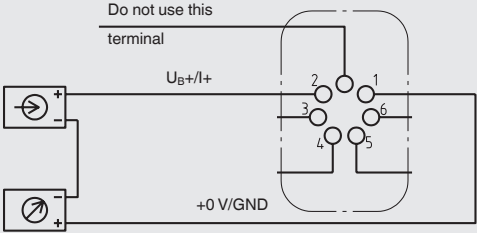
|  |  |
|--|--|
| <b>Output signal</b>   | Variant 1: 4 ... 20 mA, 2-wire, passive, per NAMUR NE 43<br>Variant 2: 4 ... 20 mA, for hazardous areas<br>Variant 3: 0 ... 20 mA, 3-wire<br>Variant 4: 0 ... 10 V, 3-wire   |
| <b>Supply voltage <math>U_B</math></b>   | DC 12 V < $U_B$ ≤ 30 V (variant 1 and 3)<br>DC 14 V < $U_B$ ≤ 30 V (variant 2)<br>DC 15 V < $U_B$ ≤ 30 V (variant 4)   |
| <b>Influence of supply voltage</b>   | ≤ 0.1 % of full scale/10 V   |
| <b>Permissible residual ripple of <math>U_B</math></b>                                       | ≤ 10 % ss  |
| <b>Permissible max. load <math>R_A</math></b>  | Variant 1, 2, 3: $R_A \leq (U_B - 12 \text{ V})/0.02 \text{ A}$ with $R_A$ in $\Omega$ and $U_B$ in V, however max. 600 $\Omega$<br>Variant 4: $R_A = 100 \text{ k}\Omega$   |
| <b>Effect of load (variant 1, 2, 3)</b>  | ≤ 0.1 % of full scale  |
| <b>Impedance at voltage output</b>   | 0.5 $\Omega$   |
| <b>Electrical zero point</b>   | Through a jumper across terminals 5 and 6 (see operating instructions)   |
| <b>Long-term stability of electronics</b>  | < 0.3 % of full scale per year   |
| <b>Electr. output signal</b>   | ≤ 1 % of measuring span  |
| <b>Linear error</b>  | ≤ 1 % of measuring span (terminal method)  |
| <b>Resolution</b>  | 0.13 % of full scale (10 bit resolution at 360°)   |
| <b>Refresh rate (measuring rate)</b>   | 600 ms   |
| <b>Electrical connection</b>   | Cable socket PA 6, black<br>Per VDE 0110 insulation group C/250 V<br>Cable gland M20 x 1.5<br>Strain relief<br>6 screw terminals + PE for conductor cross-section 2.5 mm <sup>2</sup>  |
| <b>Designation of connection terminals, 2-wire (variant 1 and 2)</b>                         |  <p>Do not use this terminal</p> <p><math>U_B+/I+</math></p> <p>3</p> <p>4</p> <p>5</p> <p>6</p> <p>+0 V/GND</p> <p>Terminals 3 and 4: For internal use only<br/>Terminals 5 and 6: Reset zero point</p> |
| Designation of connection terminals for 3-wire (variant 3 and 4), see operating instructions |  |

### Safety-related maximum values (variant 2)











| $U_i$   | $I_i$  | $P_i$  | $C_i$ | $L_i$      |
|---------|--------|--------|-------|------------|
| DC 30 V | 100 mA | 720 mW | 11 nF | negligible |

### Permissible temperature ranges (variant 2)

| T6             | T5             | T4 ... T1      |
|----------------|----------------|----------------|
| -20 ... +45 °C | -20 ... +60 °C | -20 ... +70 °C |
| T85°C          | T100°C         | T135°C         |
| -20 ... +45 °C | -20 ... +60 °C | -20 ... +70 °C |

For further information on hazardous areas, see operating instructions.

## Approvals

| Logo   | Description  | Country                     |
|--|--|-----------------------------|
| <br> | <b>EU declaration of conformity</b><br><ul style="list-style-type: none"> <li>■ EMC directive</li> <li>■ Pressure equipment directive</li> <li>■ RoHS directive</li> <li>■ ATEX directive (option)</li> </ul> Hazardous areas<br>- Ex ia Gas [II 2G Ex ia IIC T6/T5/T4 Gb] <sup>1)</sup><br>Dust [II 2D Ex ia IIIB T85°C/T100°C/T135°C Db] <sup>2)</sup> | European Union              |
| <br> | <b>IECEX (option)</b><br>Hazardous areas<br>- Ex ia Gas [Ex ia IIC T6/T5/T4 Gb] <sup>1)</sup><br>Dust [Ex ia IIIB T85°C/T100°C/T135°C Db] <sup>2)</sup>  | International               |
|   | <b>EAC (option)</b><br><ul style="list-style-type: none"> <li>■ EMC directive</li> <li>■ Low voltage directive</li> <li>■ Hazardous areas</li> </ul>   | Eurasian Economic Community |
|   | <b>GOST (option)</b><br>Metrology, measurement technology  | Russia                      |
|   | <b>KazInMetr (option)</b><br>Metrology, measurement technology   | Kazakhstan                  |
| -  | <b>MTSCHS (option)</b><br>Permission for commissioning   | Kazakhstan                  |
|   | <b>BelGIM (option)</b><br>Metrology, measurement technology  | Belarus                     |
|   | <b>UkrSEPRO (option)</b><br>Metrology, measurement technology  | Ukraine                     |
|   | <b>Uzstandard (option)</b><br>Metrology, measurement technology  | Uzbekistan                  |
|   | <b>DNOP (MakNII)</b><br>Hazardous areas  | Ukraine                     |
| -  | <b>CRN</b><br>Safety (e.g. electr. safety, overpressure, ...)  | Canada                      |

1) For instruments with PTFE lining, measures must be taken in the lining area, if necessary, in order to exclude electrostatic charging.

2) Only for instruments without PTFE lining

## Certificates (option)

- 2.2 test report per EN 10204 (e.g. state-of-the-art manufacturing, indication accuracy)
- 3.1 inspection certificate per EN 10204 (e.g. indication accuracy)

## Patents, property rights

Pointer measuring instrument with output signal 4 ... 20 mA (patent, property right: e.g. DE 202007019025, US 2010045366, CN 101438333)

Approvals and certificates, see website

## Dimensions in mm

intelliGAUGE® models PGT43HP.100 and PGT43HP.160

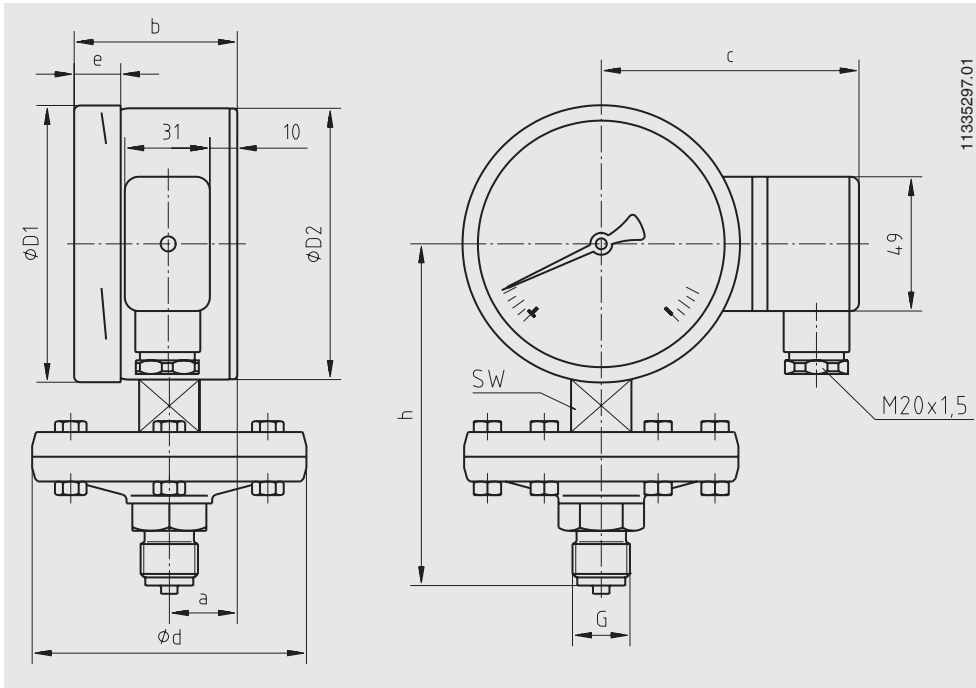

| NS  | Scale range | Overload safety | Dimensions in mm |      |     |     |     |     |    |       |      |    | Weight in kg |
|-----|-------------|-----------------|------------------|------|-----|-----|-----|-----|----|-------|------|----|--------------|
|     | in bar      |                 | a                | b    | c   | d   | D1  | D2  | e  | G     | h ±2 | SW |              |
| 100 | ≤ 0.25      | 40              | 25               | 59.5 | 94  | 160 | 101 | 99  | 17 | G ½ B | 135  | 27 | 3.4          |
|     |             | 100             | 25               | 59.5 | 94  | 160 | 101 | 99  | 17 | G ½ B | 143  | 22 | 6.3          |
|     | > 0.25      | 40              | 25               | 59.5 | 94  | 100 | 101 | 99  | 17 | G ½ B | 135  | 27 | 1.7          |
|     |             | 100             | 25               | 59.5 | 94  | 100 | 101 | 99  | 17 | G ½ B | 135  | 27 | 1.8          |
| 160 | ≤ 0.25      | 40              | 25               | 65   | 124 | 160 | 161 | 159 | 17 | G ½ B | 165  | 27 | 4.0          |
|     |             | 100             | 25               | 65   | 124 | 160 | 161 | 159 | 17 | G ½ B | 173  | 22 | 6.9          |
|     | > 0.25      | 40              | 25               | 65   | 124 | 100 | 161 | 159 | 17 | G ½ B | 165  | 27 | 2.2          |
|     |             | 100             | 25               | 65   | 124 | 100 | 161 | 159 | 17 | G ½ B | 165  | 27 | 2.3          |
|     |             | 400             | 25               | 65   | 124 | 128 | 161 | 159 | 17 | G ½ B | 199  | 22 | 6.9          |

### Ordering information

Model / Nominal size / Scale range / Output signal / Connection location / Process connection / Options

© 11/2007 WIKA Alexander Wiegand SE & Co. KG, all rights reserved.  
The specifications given in this document represent the state of engineering at the time of publishing.  
We reserve the right to make modifications to the specifications and materials.

